



The Air Cleaners

W 3	EN ISO 21904-1	W 3
	$\eta \geq 99\%$	



StrongMaster

THE LONG RUNNER

Benefits:

- ✓ **High extraction** performance
- ✓ **Long** filter service life
- ✓ **Cleanable** filter
- ✓ Optional **special equipment**

teka.eu/StrongMaster

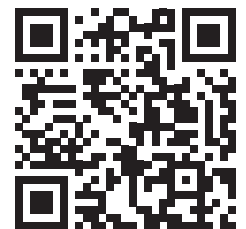

THE CLEANEST PLACE IN THE WORLD: **YOUR WORKPLACE**



Extremely powerful extraction performance

Even with high smoke volumes, the system reliably captures smoke and dust



Optionally upgradable

Available with lighted hood and automatic start-stop system



Manual cleanable filter

Significantly longer service life compared to storage filters



Simple control

Switch on and get started straight away without complicated settings





Optional accessories Art. No. 96323



Optional accessories Art. No. 97056



TECHNICALLY CONVINCING EVERYTHING AT A GLANCE



TECHNICAL DATA

Filter level 1	Filter cartridge	Power consumption	2,5 A
Filter surface*	10 m ²	Type of current	3 Ph+N+PE
Filter material	Polyester	Noise level	ca. 72 dB(A)
Filter class	Dust class M	Dimensions (W x D x H)	665 x 823 x 1.363 mm
Optional filters	Activated charcoal	Weight	ca. 165 kg
max. fan capacity	1.860 m ³ /h	IFA approval	W3-Geprüft
max. pressure	2.900 Pa	Degree of separation	≥ 99
Operating point	1.210 m ³ /h at 1.900 Pa	Colour	RAL 7016
Motor power	1,1 kW	Connection of extraction element	1x NW 160 mm
Supply voltage	400 V		
Mains frequency	50 Hz		

ACCESSORIES

Art. No.	Execution
10372	Spark guard for extraction hood
68130000100	Filter additive NANNOX P50, 100 g bucket
68130000400	Filter additive NANNOX P50, 400 g bucket
104901	Metal extraction hood NW 150
96313321	On/off switch via extraction hood, pre-assembled (only for initial equipment)
96323	Lighting kit, pre-assembled (only with original equipment)
66210	Square nozzle plate, 300 x 300 mm, PVC, black (only for plastic hood)
66220	Round nozzle plate, 400 mm, PVC, black (only for plastic hood)
10030250	Set of 10 dust bags
97056	Activated charcoal filter removal set
100090	GORETEX star filter cartridge
6160600212508	Easy-Clean-Plus filter cartridge 327 x 600 mm, 12.5 m ²

SPARE PARTS

Art. No.	Execution
6160600110008	Filter cartridge 327 x 600 mm, 10 m ² , dust class M (original equipment)
66200	Standard extraction hood incl. throttle valve
101926	Replacement hose for extraction arm 3m
101927	Replacement hose for extraction arm 4m
1003310001	Rubber band for suction arm NW 150 Colour: black
101907	Set of brake discs for extraction arm NW 150 mm
978009	Extraction arm complete

TECHNICALLY CONVINCING EVERYTHING AT A GLANCE

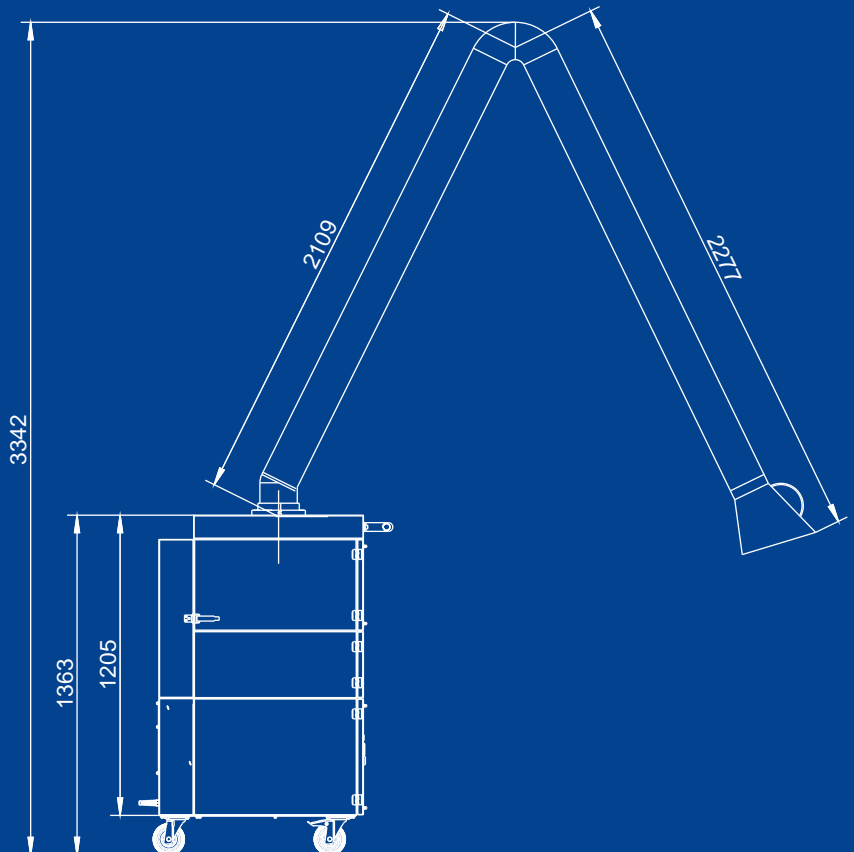
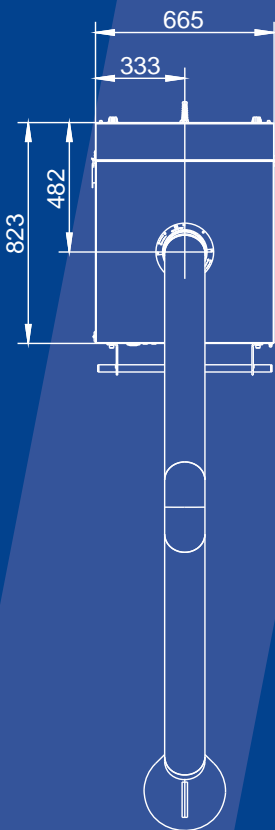
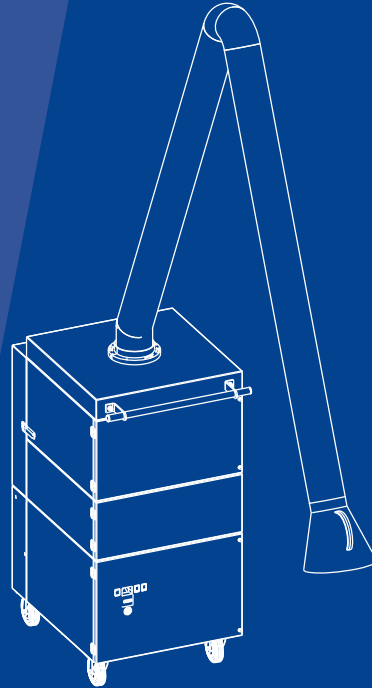
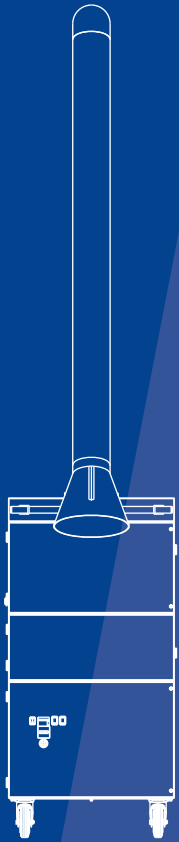

100 % SERVICE, 100 % SAFETY

THE 360° SERVICE CONTRACT



Your benefits:



Save money in the future

Service conditions are more cost-effective than maintenance on request



Get the maximum out of your service

Benefit from the 360° service offer all year round



Maximum operational reliability

Reduction of unnecessary downtime



We make the appointments

No more worries about upcoming maintenance appointments



First-class support

Prioritised scheduling when time is of the essence

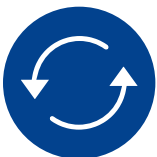

Warranty extension

We extend the warranty period to 36 months

Do you still have questions or would you like to enjoy the benefits of the 360° service package?

Get in touch with us!

Phone +49 2541 84 84 1-428

info@teka.eu

www.teka.eu/service-date



OUR PRINCIPLES FOR AN EXTRACTION SYSTEM

**Solution orientated:**

We don't see the problem, we find the solution.

**Customer focus:**

Together we develop suitable solutions, customised specifically for you.

**Reliable products:**

Performance and functionality take centre stage.

**Sustainability:**

Environmentally friendly production is important to us.

**Qualified advice on site:**

Our dealer network offers competent support.

**Strong partners:**

Benefit from the expertise of our partners in various areas.

**Complete service:**

We accompany you from consultation to maintenance.

**Almost 30 years of experience:**

We are the world market leader in filter and extraction technology.

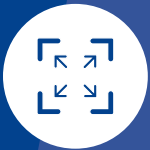
**Versatile in use:**

Our products are suitable for all applications and industries.

**Legal compliance:**

We help you to comply with legal requirements.

**Employee health:**

Our solutions reduce the risk of dangerous long-term illnesses.

**Employer attractiveness:**

Clean workplaces are a basic requirement for basic equipment for skilled workers.

**Employee motivation:**

Healthy employees are more motivated.

**Cost reduction:**

Clean environments protect machines and reduce maintenance costs

MAKE YOUR WORKPLACE **THE CLEANEST PLACE IN THE WORLD**

For almost 30 years, we have been ensuring healthy air wherever smoke and dust arise in the workplace. Whether in industry, laboratories or offices - there is always a solution for clean air. We develop a suitable concept together with our customers, because we are the special machine builders, the occupational safety professionals or simply #dieLuftreiniger.

TEKA Absaug- und Entsorgungstechnologie GmbH

Millenkamp 9 · 48653 Coesfeld · Germany

Tel. +49 2541 84 84 1-0

info@teka.eu

www.teka.eu



[@teka.die.luftreiniger](https://www.instagram.com/teka.die.luftreiniger)

